

Furon[®] Grab Seal[™] Fittings

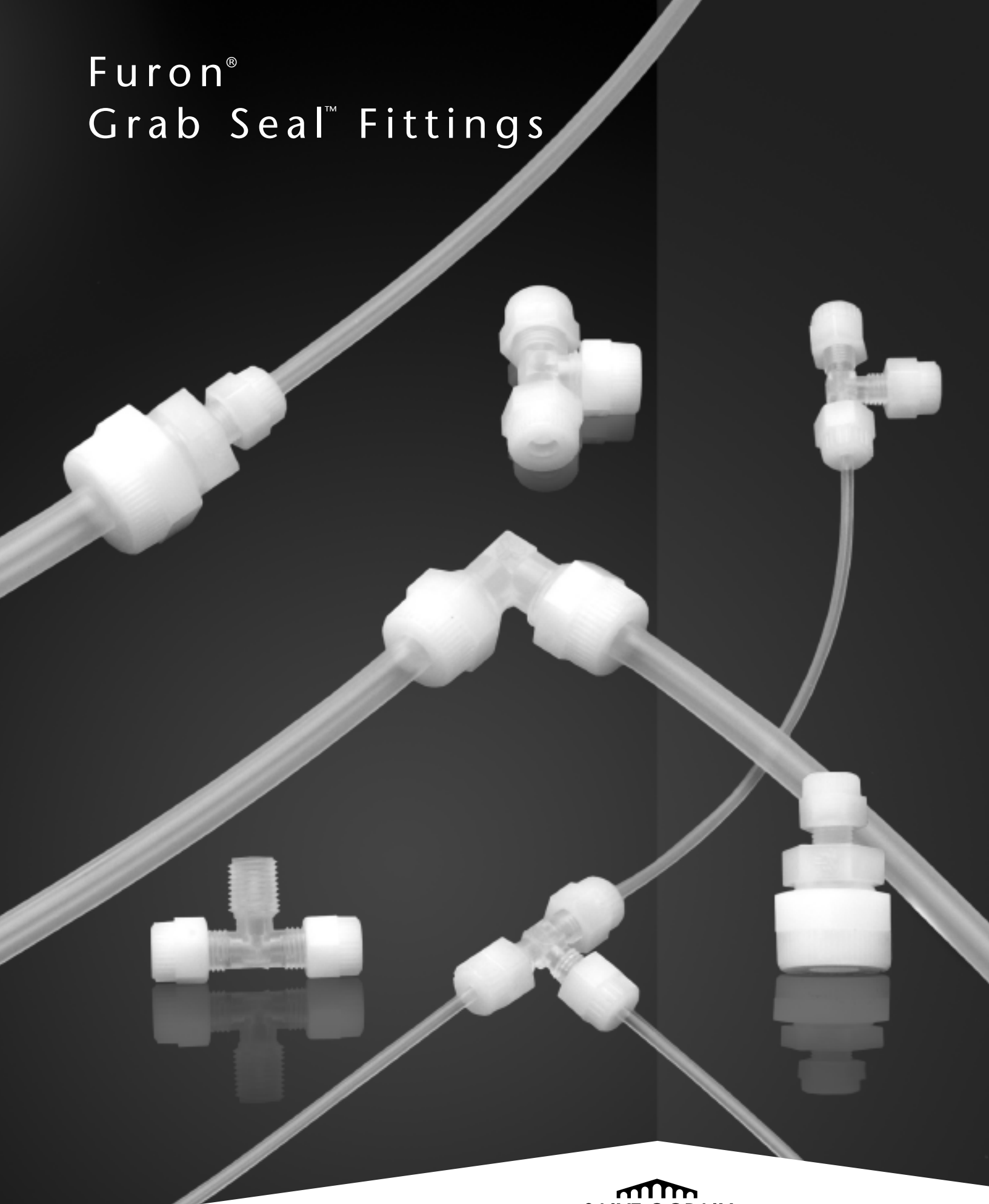

Furon® Grab Seal™ Fittings

The Furon Grab Seal compression fitting line offers PFA purity combined with the robust compression style fitting. These fittings are ideal for gas or pneumatic connections in applications that do not require flared connections. Once tubing has been cut to the desired length, Grab Seal fittings require no tools for installation. The fittings are available in 1/8", 1/4", 3/8", 1/2", 3/4" and 1" sizes.

Features/Benefits:

- Simple design for ease of installation
- No special tools required
- Accommodates temperatures up to 212° F (100°C)

We use 100% virgin HP PFA to give you the ultimate in purity and the minimum in contamination.

Each Furon PFA fitting is carefully inspected to assure quality and reliability in your application and throughout the life of the product. For service or additional application information, please call your local distributor for immediate service.

Summary of Properties

Saint Gobain, a leader for over 35 years in Fluoropolymer technology, manufactures PFA fittings for handling corrosive or ultrapure fluids under contamination-free conditions. Fluid handling applications include biomedical, chemical, petrochemical, food processing, and semiconductor industries.

Whether it be a simple fluid handling system or a complex laboratory layout, Furon PFA fittings with Grab Seal save precious time and money, and provide all the reliability needed for successful applications.

Using Tubing and Fittings

Though our fittings may be used on quartz, brass, stainless steel, or other plastics, the pressure rating is based on PFA tubing. By using the temperature chart below, derate the tubing pressures and fitting pressures accordingly. Undersized tubing may limit the working pressure of the fitting.

Allowable Pressures at 73° F for PFA Tubing and Fittings

TUBE O.D.	MAX.	TUBE O.D.	MAX.
1/8	150 PSI	1/2	125 PSI
1/4	150 PSI	3/4	100 PSI
3/8	150 PSI	1	75 PSI

We also offer a complete line of industry standard Furon Flare Grip® II flare style fittings. Please contact us at **1-800-833-5661** or visit our website **www.microelectronics.saint-gobain.com** for additional information.

Materials of Construction

Body: High Purity PFA
Gripper: PVDF
Ferrule: PTFE
Nut: ETFE

Fitting Installation

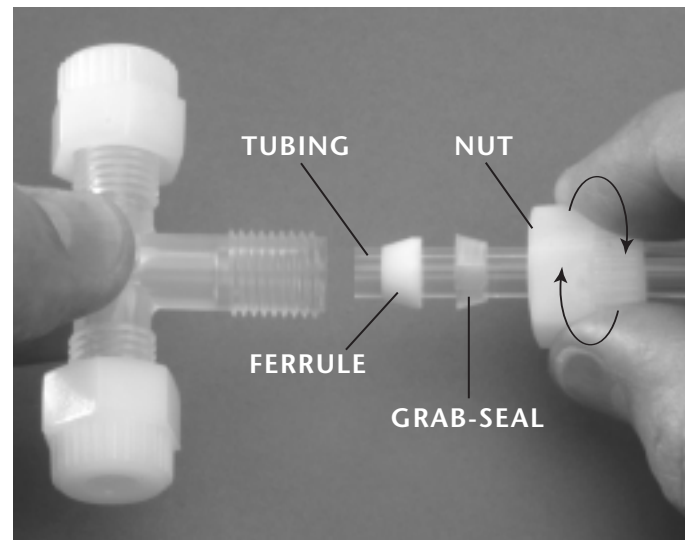

1. Cut tubing to desired length.
2. Loosen the nut, insert tube (your pre-assembled fitting should be ready for use).
3. Tighten the nut finger tight
4. Your fitting is now ready for use.

No tools are required, but if you decide to use a mechanical device to tighten it, rotate the nut no more than a 1/2 turn past finger tight.

Grab Seal™ PFA Compression Fittings (IMP)

Union Adapter Male Grab Seal Connector Male NPT Threads

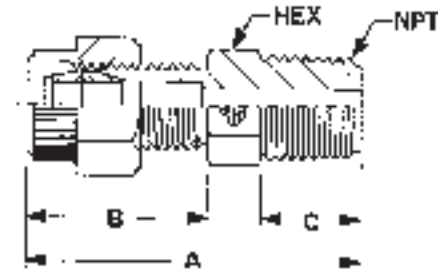

Part No.	O.D. Tube Size	Male NPT Size	Orifice	A	B	C	Hex Flat
IMP22UAM	1/8	1/8	0.09 (02.29 mm)	1.40 (35.56 mm)	0.73 (18.54 mm)	0.40 (10.17 mm)	0.45
IMP24UAM	1/8	1/4	0.09 (02.29 mm)	1.50 (38.10 mm)	0.73 (18.54 mm)	0.50 (12.71 mm)	0.50
IMP42UAM	1/4	1/8	0.19 (04.83 mm)	1.47 (37.34 mm)	0.80 (20.32 mm)	0.40 (10.17 mm)	0.44
IMP44UAM	1/4	1/4	0.19 (04.83 mm)	1.58 (40.13 mm)	0.81 (20.57 mm)	0.5 (12.70 mm)	0.50
IMP46UAM	1/4	3/8	0.19 (04.83 mm)	1.67 (42.42 mm)	0.80 (20.32 mm)	0.5 (12.70 mm)	0.68
IMP48UAM	1/4	1/2	0.19 (04.83 mm)	1.80 (45.72 mm)	0.80 (20.32 mm)	0.63 (16.00 mm)	0.87
IMP62UAM	3/8	1/8	0.19 (04.83 mm)	1.61 (40.89 mm)	0.84 (21.34 mm)	0.40 (10.17 mm)	0.68
IMP64UAM	3/8	1/4	0.31 (07.87 mm)	1.71 (43.43 mm)	0.84 (21.34 mm)	0.50 (12.71 mm)	0.68
IMP66UAM	3/8	3/8	0.31 (07.87 mm)	1.71 (43.43 mm)	0.84 (21.34 mm)	0.50 (12.71 mm)	0.68
IMP68UAM	3/8	1/2	0.31 (07.87 mm)	1.84 (46.74 mm)	0.84 (21.34 mm)	0.63 (16.00 mm)	0.87
IMP84UAM	1/2	1/4	0.29 (07.37 mm)	1.81 (45.97 mm)	0.94 (23.88 mm)	0.50 (12.71 mm)	0.87
IMP86UAM	1/2	3/8	0.42 (10.67 mm)	1.81 (45.97 mm)	0.94 (23.88 mm)	0.50 (12.71 mm)	0.87
IMP88UAM	1/2	1/2	0.46 (11.68 mm)	1.95 (49.53 mm)	0.94 (23.88 mm)	0.64 (16.26 mm)	0.87
IMP812UAM*	1/2	3/4	0.46 (11.68 mm)	2.18 (55.37 mm)	0.88 (22.35 mm)	0.80 (20.33 mm)	1.12
IMP128UAM*	3/4	1/2	0.46 (11.68 mm)	2.21 (56.13 mm)	1.07 (27.18 mm)	0.64 (16.26 mm)	1.38
IMP1212UAM	3/4	3/4	0.68 (17.27 mm)	2.34 (59.44 mm)	1.04 (26.42 mm)	0.80 (20.33 mm)	1.38
IMP1216UAM	3/4	1	0.68 (17.27 mm)	2.51 (63.75 mm)	1.07 (27.18 mm)	0.94 (23.88 mm)	1.38
IMP1612UAM*	1	3/4	0.75 (19.05 mm)	2.48 (62.99 mm)	1.18 (29.97 mm)	0.80 (20.33 mm)	1.38
IMP1616UAM	1	1	0.94 (23.88 mm)	2.62 (66.55 mm)	1.18 (29.97 mm)	0.94 (23.88 mm)	1.38

Elbow Adapter Male Grab Seal Connector Male NPT Threads

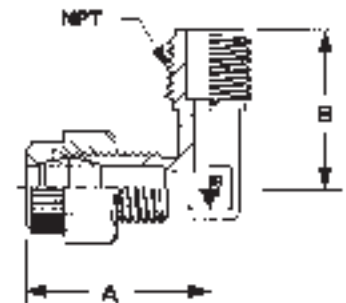

Part No.	O.D. Tube Size	Male NPT Size	Orifice	A	B
IMP22EAM	1/8	1/8	0.09 (02.29 mm)	0.73 (18.54 mm)	0.72 (18.29 mm)
IMP24EAM	1/8	1/4	0.09 (02.29 mm)	0.99 (25.15 mm)	0.78 (19.81 mm)
IMP42EAM	1/4	1/8	0.19 (04.83 mm)	1.05 (26.67 mm)	0.71 (18.03 mm)
IMP44EAM	1/4	1/4	0.19 (04.83 mm)	1.05 (26.67 mm)	0.97 (24.64 mm)
IMP46EAM	1/4	3/8	0.19 (04.83 mm)	1.16 (29.46 mm)	0.85 (21.59 mm)
IMP62EAM*	3/8	1/8	0.19 (04.83 mm)	1.19 (30.23 mm)	0.85 (21.59 mm)
IMP64EAM	3/8	1/4	0.31 (07.87 mm)	1.19 (30.23 mm)	0.95 (24.13 mm)
IMP66EAM	3/8	3/8	0.31 (07.87 mm)	1.18 (29.97 mm)	1.05 (26.67 mm)
IMP68EAM*	3/8	1/2	0.31 (07.87 mm)	1.28 (32.51 mm)	1.13 (28.70 mm)
IMP84EAM*	1/2	1/4	0.31 (07.87 mm)	1.28 (32.51 mm)	1.13 (28.70 mm)
IMP86EAM	1/2	3/8	0.42 (10.67 mm)	1.28 (32.51 mm)	1.13 (28.70 mm)
IMP88EAM	1/2	1/2	0.46 (11.68 mm)	1.36 (34.54 mm)	1.13 (28.70 mm)
IMP812EAM*	1/2	3/4	0.46 (11.68 mm)	1.57 (39.88 mm)	1.50 (38.10 mm)
IMP128EAM*	3/4	1/2	0.50 (12.70 mm)	1.64 (41.66 mm)	1.38 (35.05 mm)
IMP1212EAM*	3/4	3/4	0.68 (17.27 mm)	1.65 (41.91 mm)	1.50 (38.10 mm)
IMP1216EAM*	3/4	1	0.68 (17.27 mm)	1.83 (46.48 mm)	1.75 (44.45 mm)
IMP1612EAM*	1	3/4	0.75 (19.05 mm)	2.05 (52.07 mm)	1.75 (44.45 mm)
IMP1616EAM*	1	1	0.94 (23.88 mm)	2.05 (52.07 mm)	1.88 (47.75 mm)

NOTE: *Subject to minimum order requirements. Consult factory for further details.

Grab Seal™ PFA Compression Fittings (IMP)

Elbow Adapter Female

Grab Seal Connector
Female NPT Threads

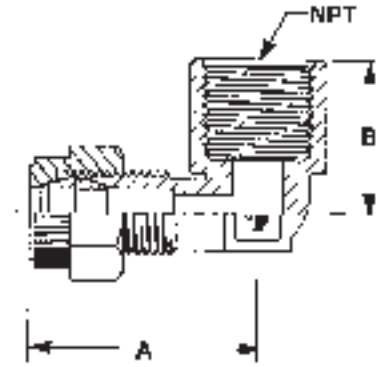

Part No.	O.D. Tube Size	Female NPT Size	Orifice	A	B
IMP44EAF	1/4	1/4	0.09 (02.29 mm)	1.27 (32.26 mm)	0.80 (20.32 mm)
IMP64EAF	3/8	1/4	0.31 (07.87 mm)	1.32 (33.53 mm)	1.00 (25.40 mm)
IMP66EAF*	3/8	3/8	0.31 (07.87 mm)	1.40 (35.66 mm)	1.00 (25.40 mm)
IMP68EAF*	3/8	1/2	0.31 (07.87 mm)	1.59 (40.39 mm)	1.12 (28.45 mm)
IMP86EAF*	1/2	3/8	0.44 (11.18 mm)	1.50 (38.10 mm)	1.12 (28.45 mm)
IMP88EAF*	1/2	1/2	0.40 (10.16 mm)	1.63 (41.40 mm)	1.25 (31.75 mm)
IMP1212EAF	3/4	3/4	0.68 (17.27 mm)	1.83 (46.48 mm)	1.62 (41.15 mm)
IMP1616EAF*	1	1	0.94 (23.88 mm)	2.05 (52.07 mm)	1.88 (47.75 mm)

Male Run Tee

Grab Seal Connector
Male NPT Threads

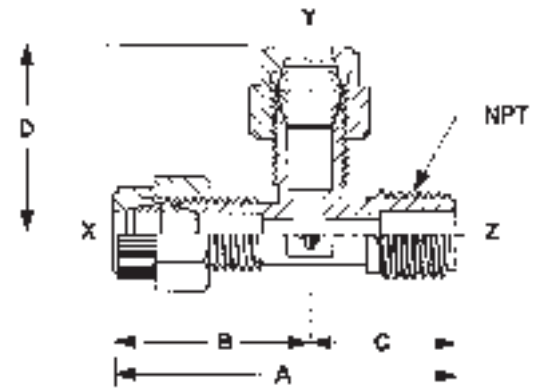

Part No.	O.D. Tube Size X	O.D. Tube Size Y	Male NPT Size Z	Orifice	A	B	C	D
IMP2MRT*	1/8	1/8	1/8	0.09 (02.29 mm)	1.70 (43.18 mm)	0.92 (23.37 mm)	0.78 (19.81 mm)	0.92 (23.37 mm)
IMP4MRT	1/4	1/4	1/4	0.19 (04.83 mm)	1.90 (48.26 mm)	1.05 (26.67 mm)	0.85 (21.59 mm)	1.05 (26.67 mm)
IMP6MRT*	3/8	3/8	3/8	0.31 (07.87 mm)	2.13 (54.10 mm)	1.19 (30.23 mm)	0.94 (23.88 mm)	1.19 (30.23 mm)
IMP8MRT	1/2	1/2	1/2	0.44 (11.18 mm)	2.62 (66.55 mm)	1.39 (35.31 mm)	1.23 (31.24 mm)	1.39 (35.31 mm)
IMP12MRT*	3/4	3/4	3/4	0.69 (17.53 mm)	3.31 (84.07 mm)	1.81 (45.97 mm)	1.50 (38.10 mm)	1.81 (45.97 mm)
IMP16MRT	1	1	1	0.94 (23.88 mm)	3.93 (99.82 mm)	2.05 (52.07 mm)	1.88 (47.75 mm)	2.05 (52.07 mm)

Grab Seal™ PFA Compression Fittings (IMP)

Straight Union Grab Seal Connector

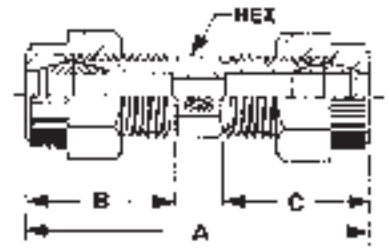

Part No.	O.D. Tube Size	Orifice	A	B	C	Hex Flat
IMP2SU	1/8	0.09 (02.29 mm)	1.84 (46.74 mm)	0.73 (18.54 mm)	0.73 (18.54 mm)	0.38
IMP4SU	1/4	0.19 (04.83 mm)	1.87 (47.50 mm)	0.80 (20.32 mm)	0.80 (20.32 mm)	0.38
IMP6SU	3/8	0.31 (07.87 mm)	2.05 (52.07 mm)	0.84 (21.34 mm)	0.84 (21.34 mm)	0.68
IMP8SU	1/2	0.44 (11.18 mm)	2.23 (56.64 mm)	0.93 (23.62 mm)	0.93 (23.62 mm)	0.87
IMP12SU*	3/4	0.69 (17.53 mm)	2.64 (67.06 mm)	1.07 (27.18 mm)	1.07 (27.18 mm)	1.38
IMP16SU*	1	0.94 (23.88 mm)	2.86 (72.64 mm)	1.18 (29.97 mm)	1.18 (29.97 mm)	1.38

Union Adapter Female Grab Seal Connector Female NPT Threads

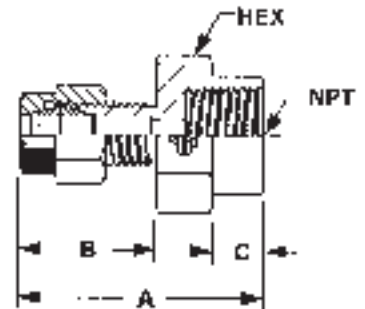

Part No.	O.D. Tube Size	Female NPT Size	Orifice	A	B	C	Hex Flat
IMP42UAF*	1/4	1/8	0.19 (04.83 mm)	1.38 (35.05 mm)	0.80 (20.32 mm)	0.31 (07.87 mm)	0.56
IMP44UAF*	1/4	1/4	0.19 (04.83 mm)	1.52 (38.61 mm)	0.80 (20.32 mm)	0.34 (08.64 mm)	0.94
IMP46UAF*	1/4	3/8	0.19 (04.83 mm)	1.48 (37.59 mm)	0.80 (20.32 mm)	0.31 (07.87 mm)	1.00
IMP48UAF*	1/4	1/2	0.19 (04.83 mm)	1.57 (39.88 mm)	0.80 (20.32 mm)	0.40 (10.16 mm)	1.13
IMP62UAF*	3/8	1/8	0.25 (06.35 mm)	1.52 (38.61 mm)	0.84 (21.34 mm)	0.31 (7.87 mm)	0.69
IMP64UAF*	3/8	1/4	0.31 (07.87 mm)	1.53 (38.86 mm)	0.84 (21.34 mm)	0.32 (08.13 mm)	0.94
IMP66UAF*	3/8	3/8	0.31 (07.87 mm)	1.52 (38.61 mm)	0.84 (21.34 mm)	0.31 (07.87 mm)	1.00
IMP68UAF*	3/8	1/2	0.31 (07.87 mm)	1.61 (40.89 mm)	0.84 (21.34 mm)	0.40 (10.16 mm)	1.13
IMP84UAF*	1/2	1/4	0.31 (07.87 mm)	1.61 (40.89 mm)	0.94 (23.88 mm)	0.30 (07.62 mm)	0.88
IMP86UAF*	1/2	3/8	0.45 (11.43 mm)	1.63 (41.40 mm)	0.94 (23.88 mm)	0.32 (08.13 mm)	1.13
IMP88UAF*	1/2	1/2	0.46 (11.68 mm)	1.73 (43.94 mm)	0.94 (23.88 mm)	0.42 (10.67 mm)	1.13
IMP812UAF*	1/2	3/4	0.46 (11.68 mm)	1.82 (46.23 mm)	0.94 (23.88 mm)	0.38 (09.63 mm)	1.38
IMP128UAF	3/4	1/2	0.50 (12.70 mm)	1.97 (50.04 mm)	1.07 (27.18 mm)	0.40 (10.16 mm)	1.38
IMP1212UAF*	3/4	3/4	0.69 (17.53 mm)	2.00 (50.80 mm)	1.10 (27.94 mm)	0.40 (10.16 mm)	1.63
IMP1216UAF*	3/4	1	0.69 (17.53 mm)	2.20 (55.88 mm)	1.07 (27.18 mm)	0.63 (16.00 mm)	1.75
IMP1616UAF*	1	1	0.94 (23.88 mm)	2.30 (58.42 mm)	1.18 (29.97 mm)	0.62 (15.75 mm)	1.75

NOTE: *Subject to minimum order requirements. Consult factory for further details.

Grab Seal™ PFA Compression Fittings (IMP)

Male Branch Tee

Grab Seal Connector
Male NPT Threads

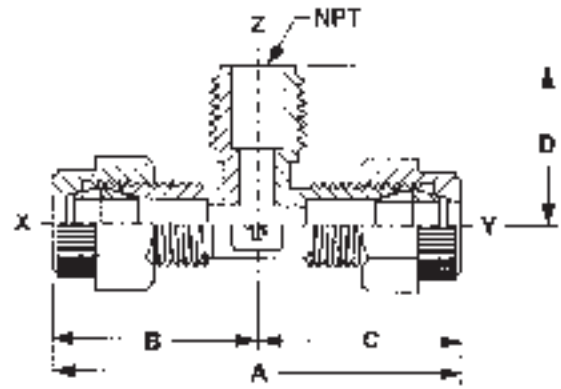

Part No.	O.D. Tube Size	O.D. Tube Size	Male NPT Size	Orifice	A	B	C	D
	X	Y	Z					
IMP2MBT*	1/8	1/8	1/8	0.09 (02.29 mm)	1.86 (47.24 mm)	0.93 (23.62 mm)	0.93 (23.62 mm)	0.78 (19.81 mm)
IMP4MBT	1/4	1/4	1/4	0.19 (04.83 mm)	2.10 (53.34 mm)	1.05 (26.67 mm)	1.05 (26.67 mm)	0.93 (23.62 mm)
IMP6MBT*	3/8	3/8	3/8	0.31 (07.87 mm)	2.38 (60.45 mm)	1.19 (30.23 mm)	1.19 (30.23 mm)	0.94 (23.88 mm)
IMP8MBT*	1/2	1/2	1/2	0.44 (11.18 mm)	2.78 (70.61 mm)	1.39 (35.31 mm)	1.39 (35.31 mm)	1.23 (31.24 mm)
IMP12MBT*	3/4	3/4	3/4	0.69 (17.53 mm)	3.62 (91.95 mm)	1.81 (45.97 mm)	1.81 (45.97 mm)	1.50 (38.10 mm)
IMP16MBT*	1	1	1	0.94 (23.88 mm)	4.10 (104.14 mm)	2.05 (52.07 mm)	2.05 (52.07 mm)	1.88 (47.75 mm)

Union Elbow

Grab Seal Connector

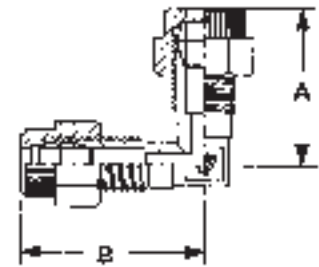

Part No.	O.D. Tube Size	Orifice	A	B
IMP2UE	1/8	0.09 (02.29 mm)	0.94 (23.88 mm)	0.94 (23.88 mm)
IMP4UE	1/4	0.19 (04.83 mm)	1.19 (30.23 mm)	1.19 (30.23 mm)
IMP6UE	3/8	0.31 (07.87 mm)	1.31 (33.27 mm)	1.31 (33.27 mm)
IMP8UE	1/2	0.44 (11.18 mm)	1.47 (37.34 mm)	1.47 (37.34 mm)
IMP12UE	3/4	0.68 (17.27 mm)	1.83 (46.48 mm)	1.83 (46.48 mm)
IMP16UE*	1	0.94 (23.88 mm)	2.05 (52.07 mm)	2.05 (52.07 mm)

Straight Union Reducer

Grab Seal Connector

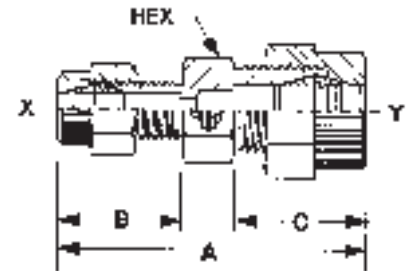

Part No.	O.D. Tube Size	O.D. Tube Size	Orifice	A	B	C	Hex Flat
	X	Y					
IMP24UR	1/8	1/4	0.09 (02.29 mm)	1.80 (45.72 mm)	0.73 (18.54 mm)	0.81 (20.57 mm)	0.38
IMP28UR*	1/8	1/2	0.09 (02.29 mm)	1.95 (49.53 mm)	0.73 (18.54 mm)	0.94 (23.88 mm)	0.94
IMP46UR	1/4	3/8	0.19 (04.83 mm)	2.01 (51.05 mm)	0.80 (20.32 mm)	0.84 (21.34 mm)	0.68
IMP48UR	1/4	1/2	0.19 (04.83 mm)	2.11 (53.59 mm)	0.80 (20.32 mm)	0.94 (23.88 mm)	0.93
IMP68UR	3/8	1/2	0.31 (07.87 mm)	2.15 (54.61 mm)	0.84 (21.34 mm)	0.94 (23.88 mm)	0.87
IMP812UR	1/2	3/4	0.70 (17.78 mm)	2.51 (63.75 mm)	0.94 (23.88 mm)	1.07 (27.18 mm)	1.375
IMP1216UR*	3/4	1	0.69 (17.53 mm)	2.75 (69.85 mm)	1.07 (27.18 mm)	1.18 (29.97 mm)	1.375
IMP128UR	3/4	1/2	0.70 (17.78 mm)	2.51 (63.75 mm)	1.07 (27.18 mm)	0.94 (23.88 mm)	1.375

Grab Seal™ PFA Compression Fittings (IMP)

Male Branch Tee Reducer Grab Seal Connector Male NPT Threads

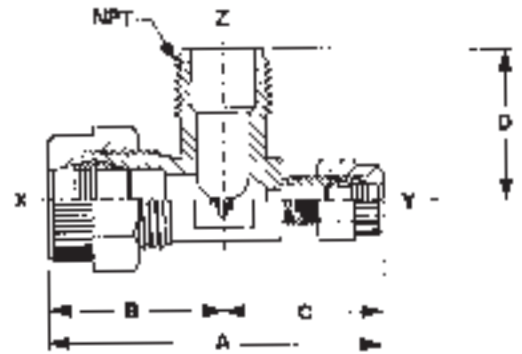

Part No.	O.D. Tube Size	O.D. Tube Size	Male NPT Size	Orifice	A	B	C	D
	X	Y	Z					
IMP424MBTR*	1/4	1/8	1/4	0.09 (02.29 mm)	2.03 (51.56 mm)	1.05 (26.67 mm)	0.98 (24.89 mm)	0.87 (22.10 mm)
IMP646MBTR	3/8	1/4	3/8	0.19 (04.83 mm)	2.40 (60.96 mm)	1.22 (30.99 mm)	1.18 (29.97 mm)	0.88 (22.35 mm)
IMP848MBTR	1/2	1/4	1/2	0.19 (04.83 mm)	2.68 (68.07 mm)	1.38 (35.05 mm)	1.30 (33.02 mm)	1.31 (34.58 mm)
IMP866MBTR	1/2	3/8	3/8	0.31 (07.87 mm)	2.75 (69.85 mm)	1.38 (35.05 mm)	1.37 (34.80 mm)	1.31 (34.58 mm)
IMP12412MBTR	3/4	1/4	3/4	0.19 (04.83 mm)	3.39 (86.11 mm)	1.82 (46.23 mm)	1.57 (39.88 mm)	1.62 (41.15 mm)

Union Tee Grab Seal Connector

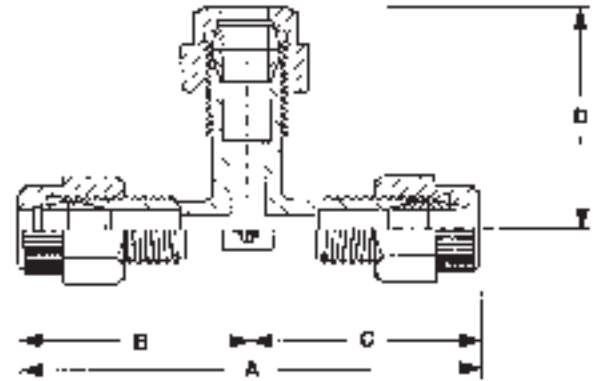

Part No.	O.D. Tube Size	Orifice	A	B	C	D
IMP2UT	1/8	0.09 (02.29 mm)	1.86 (47.24 mm)	0.93 (18.80 mm)	0.93 (23.62 mm)	0.93 (23.62 mm)
IMP4UT	1/4	0.19 (04.83 mm)	2.28 (57.91 mm)	1.14 (28.86 mm)	1.14 (28.96 mm)	1.35 (34.29 mm)
IMP6UT	3/8	0.31 (07.87 mm)	2.38 (60.45 mm)	1.19 (23.88 mm)	1.19 (30.23 mm)	1.19 (30.23 mm)
IMP8UT	1/2	0.44 (11.18 mm)	3.16 (80.26 mm)	1.58 (33.74 mm)	1.58 (40.13 mm)	1.58 (40.13 mm)
IMP12UT*	3/4	0.69 (17.53 mm)	3.62 (91.95 mm)	1.81 (37.85 mm)	1.81 (45.97 mm)	1.81 (45.97 mm)
IMP16UT*	1	0.94 (23.88 mm)	4.10 (104.14 mm)	2.05 (43.43 mm)	2.05 (52.07 mm)	2.05 (52.07 mm)

Straight Union Panel Grab Seal Connector

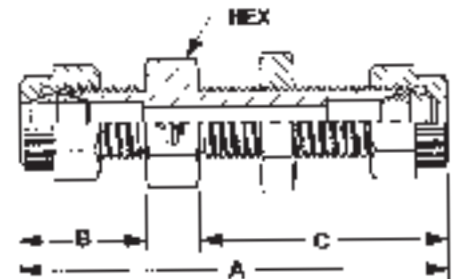

Part No.	O.D. Tube Size	Orifice	A	B	C	Hex Flat
IMP2SUP	1/8	0.09 (02.29 mm)	2.80 (71.12 mm)	0.73 (18.54 mm)	1.69 (42.93 mm)	0.56
IMP4SUP	1/4	0.19 (04.83 mm)	2.92 (74.17 mm)	0.80 (20.32 mm)	1.75 (44.45 mm)	0.68
IMP6SUP	3/8	0.31 (07.87 mm)	3.04 (77.22 mm)	0.84 (21.34 mm)	1.83 (46.48 mm)	0.94
IMP8SUP	1/2	0.44 (11.18 mm)	3.16 (80.26 mm)	0.93 (23.62 mm)	1.86 (47.24 mm)	1.12
IMP12SUP	3/4	0.69 (17.53 mm)	3.65 (92.71 mm)	1.07 (27.18 mm)	2.08 (52.83 mm)	1.38
IMP16SUP*	1	0.94 (23.88 mm)	3.86 (98.04 mm)	1.18 (29.97 mm)	2.18 (55.37 mm)	1.50

NOTE: *Subject to minimum order requirements. Consult factory for further details.

Grab Seal™ PFA Compression Fittings (IMP)

Union Elbow Reducer Grab Seal Connector

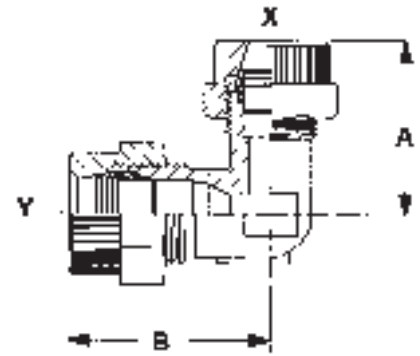

Part No.	O.D. Tube Size		Orifice	A	B
	X	Y			
IMP24UER	1/8	1/4	0.09 (02.29 mm)	1.00 (25.40 mm)	1.08 (27.43 mm)
IMP46UER	1/4	3/8	0.19 (04.83 mm)	1.16 (29.46 mm)	1.25 (31.75 mm)
IMP68UER	3/8	1/2	0.31 (07.87 mm)	1.36 (34.54 mm)	1.44 (36.58 mm)
IMP48UER*	1/4	1/2	0.25 (06.35 mm)	1.30 (33.02 mm)	1.44 (36.58 mm)
IMP812UER*	1/2	3/4	0.44 (11.18 mm)	1.74 (44.20 mm)	1.81 (45.97 mm)
IMP1216UER*	3/4	1	0.69 (17.53 mm)	1.99 (50.55 mm)	2.03 (51.56 mm)

Union Tee Reducer Grab Seal Connector

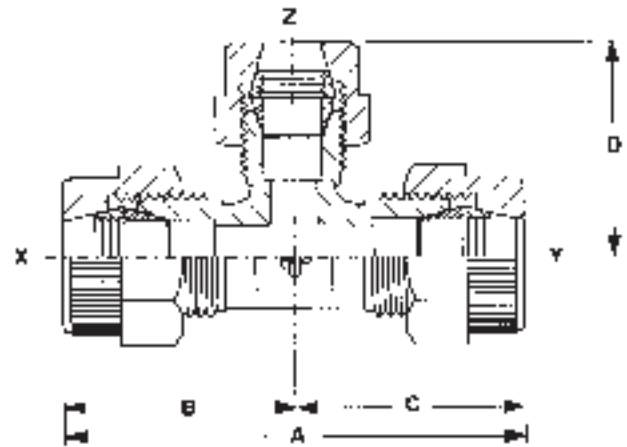

Part No.	O.D. Tube Size			Orifice	A	B	C	D
	X	Y	Z					
IMP664UTR	3/8	3/8	1/4	0.19 (04.83 mm)	2.40 (60.96 mm)	1.20 (30.48 mm)	1.20 (30.48 mm)	1.16 (29.46 mm)
IMP884UTR	1/2	1/2	1/4	0.19 (04.83 mm)	2.80 (71.12 mm)	1.40 (35.56 mm)	1.40 (35.56 mm)	1.32 (33.53 mm)
IMP886UTR*	1/2	1/2	3/8	0.31 (07.87 mm)	2.80 (71.12 mm)	1.40 (35.56 mm)	1.40 (35.56 mm)	1.36 (34.54 mm)
IMP12128UTR	3/4	3/4	1/2	0.44 (11.18 mm)	3.62 (91.95 mm)	1.81 (45.97 mm)	1.81 (45.97 mm)	1.72 (43.69 mm)

Grab Seal™ PFA Compression Fittings (IMP)

Nut

Part No.	O.D. Tube Size	A	Hex Flat
IMP2N	1/8	0.52 (13.21 mm)	0.52
IMP4N	1/4	0.56 (14.22 mm)	0.62
IMP6N	3/8	0.72 (18.29 mm)	0.87
IMP8N	1/2	0.78 (19.81 mm)	1.18
IMP12N	3/4	0.92 (23.37 mm)	1.37
IMP16N	1	0.94 (23.88 mm)	1.62

Material — Molded ETFE



Gripper

Part No.	O.D. Tube Size	A	B
IMP2G*	1/8	0.08 (05.08 mm)	0.22 (05.33 mm)
IMP4G	1/4	0.15 (05.08 mm)	0.38 (09.14 mm)
IMP6G	3/8	0.19 (06.60 mm)	0.56 (13.46 mm)
IMP8G	1/2	0.19 (07.11 mm)	0.69 (17.02 mm)
IMP12G	3/4	0.21 (08.64 mm)	0.97 (23.88 mm)
IMP16G	1	0.21 (09.40 mm)	1.22 (30.23 mm)

Material — Molded PVDF
*Machined CTFE

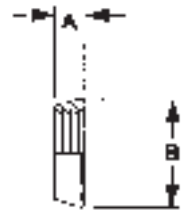

Cap

Part No.	O.D. Tube Size	A	B
SLF2C	1/8	0.88 (22.35 mm)	0.31 (07.87 mm)
SLF4C	1/4	0.88 (22.35 mm)	0.44 (11.18 mm)
SLF6C	3/8	0.88 (22.35 mm)	0.69 (17.02 mm)
SLF8C	1/2	0.94 (23.88 mm)	0.88 (22.35 mm)
SLF12C	3/4	1.00 (25.40 mm)	1.13 (28.70 mm)
SLF16C	1	1.07 (27.18 mm)	1.38 (35.05 mm)

Material — PTFE

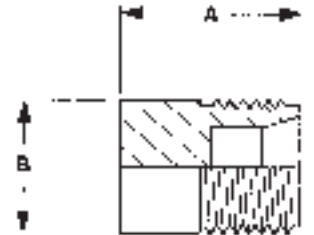

Ferrule

Part No.	O.D. Tube Size	A	B
IMP2F	1/8	0.20 (05.08 mm)	0.21 (05.33 mm)
IMP4F	1/4	0.20 (05.08 mm)	0.36 (09.14 mm)
IMP6F	3/8	0.26 (06.60 mm)	0.53 (13.46 mm)
IMP8F	1/2	0.28 (07.11 mm)	0.67 (17.02 mm)
IMP12F	3/4	0.34 (08.64 mm)	0.94 (23.88 mm)
IMP16F	1	0.37 (09.40 mm)	1.19 (30.23 mm)

Material — PTFE

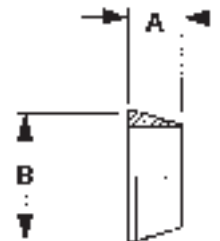

Grab Seal™ Manifold Tee

Plug

Part No.	O.D. Tube Size	A	B
IMP2P	1/8	0.39 (09.91 mm)	0.22 (02.59 mm)
IMP4P	1/4	0.57 (14.48 mm)	0.36 (09.14 mm)
IMP6P	3/8	0.71 (18.03 mm)	0.53 (13.46 mm)
IMP8P	1/2	0.75 (19.05 mm)	0.67 (17.02 mm)
IMP12P	3/4	0.88 (22.35 mm)	0.94 (23.88 mm)
IMP16P	1	0.88 (22.35 mm)	1.18 (29.97 mm)

Material — PTFE

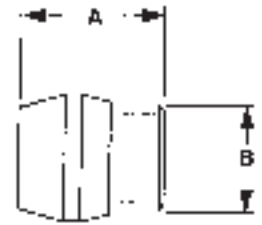

Panel Nut

Part No.	O.D. Tube Size	A	Hex Flat
IMP2PN	1/8	0.25 (06.35 mm)	0.75
IMP4PN	1/4	0.25 (06.35 mm)	0.75
IMP6PN	3/8	0.25 (06.35 mm)	1.00
IMP8PN	1/2	0.25 (06.35 mm)	1.25
IMP12PN	3/4	0.25 (06.35 mm)	1.62
IMP16PN	1	0.25 (06.35 mm)	1.62

Material — PVC

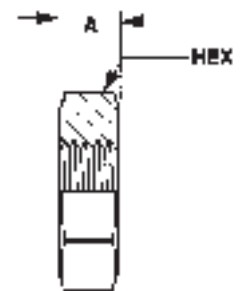

Pipe PFA Fittings, Molded

Bushing

<i>Part No.</i>	<i>Male NPT Size</i>	<i>Female NPT Size</i>	<i>A</i>	<i>Hex Flat</i>
MPF42B	1/4	1/8	0.94 (23.88 mm)	0.56
MPF64B	3/8	1/4	1.00 (25.40 mm)	0.68
MPF84B	1/2	1/4	1.00 (25.40 mm)	1.00
MPF86B	1/2	3/8	1.00 (25.40 mm)	1.00
MPF128B	3/4	1/2	1.13 (28.70 mm)	1.25

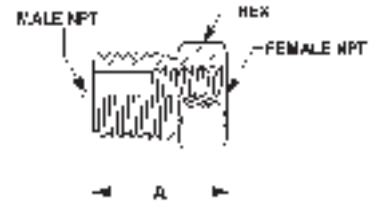

Plug

<i>Part No.</i>	<i>Male NPT Size</i>	<i>A</i>	<i>Hex Flat</i>
MPF4P	1/4	0.75 (19.05 mm)	0.50
MPF6P	3/8	0.88 (22.35 mm)	0.68
MPF8P	1/2	1.00 (25.40 mm)	0.88



Elbow

<i>Part No.</i>	<i>Female NPT Size</i>	<i>A</i>	<i>B</i>
MFP4E	1/4	0.81 (20.64 mm)	0.81 (20.64 mm)
MFP8E	1/2	1.13 (28.70 mm)	1.13 (28.70 mm)

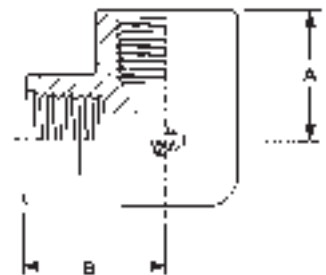

Nipple

<i>Part No.</i>	<i>Male NPT Size</i>	<i>A</i>	<i>Hex Flat</i>
MPF4N	1/4	1.25 (31.75 mm)	0.50
MPF6N	3/8	1.38 (35.05 mm)	0.68
MPF8N	1/2	1.68 (42.67 mm)	0.87
MPF12N	3/4	1.88 (47.75 mm)	1.25

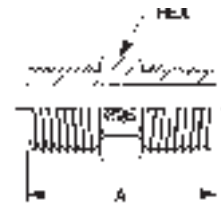

Coupling

<i>Part No.</i>	<i>Male NPT Size</i>	<i>A</i>	<i>Hex Flat</i>
MPF4C	1/4	1.50 (38.10 mm)	0.81
MPF8C	1/2	1.50 (38.10 mm)	1.25

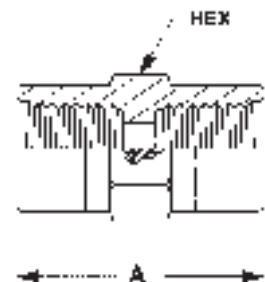

Tee

<i>Part No.</i>	<i>Male NPT Size</i>	<i>A</i>	<i>B</i>
MPF4T	1/4	1.63 (41.40 mm)	0.81 (20.64 mm)
MPF8T	1/2	2.25 (57.15 mm)	1.13 (28.70 mm)

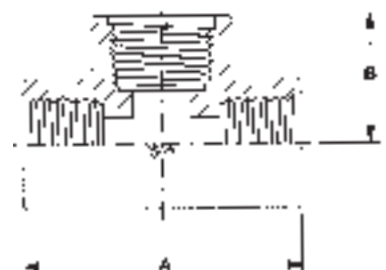

Saint-Gobain Performance Plastics - USA
7301 Orangewood Avenue
Garden Grove, CA 92841-1411
Tel: (714) 630-5818
Fax: (714) 688-2614
USA Toll Free: (800) 833-5661

Saint-Gobain Performance Plastics-France
41 Boulevard des Bouvets
Nanterre F-92000, France
Tel: 33 / (0) 1 55 68 59 59
Fax: 33 / (0) 1 55 68 59 68



Furon® is a registered trademark.
Flare Grip® is a registered trademark.

12-month **Limited Warranty:** For a period of 12 months from the date of first sale, Saint-Gobain Performance Plastics Corporation warrants this product to be free from defects in manufacturing. This company's only obligation will be to provide replacement product for any material proven to have such a defect, or at SGPL's option, to refund the purchase price thereof. User assumes all other risks, if any, including the risk of injury, loss or damage, whether direct, consequential or incidental, arising out of the use, misuse, or inability to use this product. SAINT-GOBAIN PERFORMANCE PLASTICS DISCLAIMS ALL IMPLIED WARRANTIES OF MERCHANTABILITY AND FITNESS FOR A PARTICULAR PURPOSE.

NOTE: Saint-Gobain Performance Plastics Corporation does not assume any responsibility or liability for any advice furnished by it, or for the performance or results of any installation or use of the product or of any final product into which the product may be incorporated by the purchaser and/or user.